

# BellyBandCasings

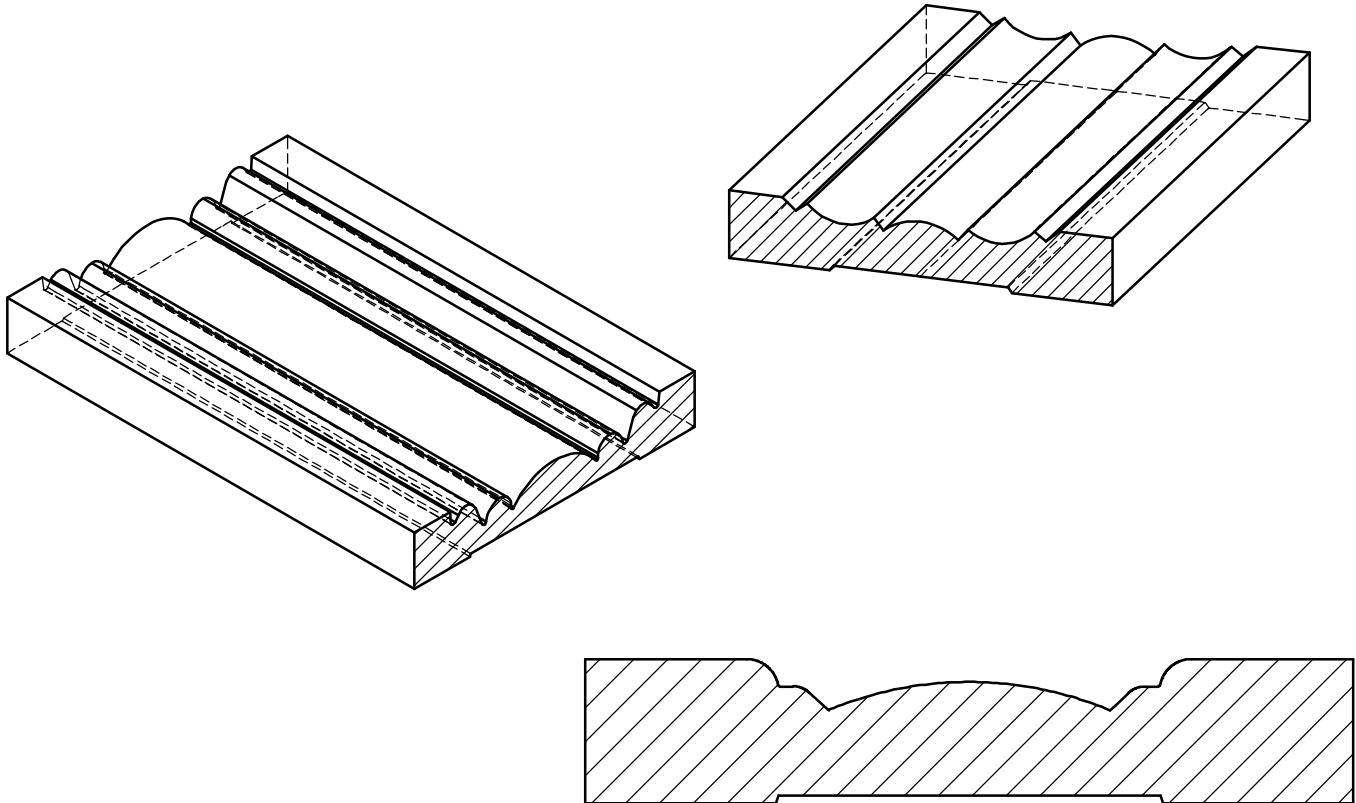

## N.E.W.P PART NUMBER CROSS REFERENCE

NEWP#	OLDNEWP#	Thick-Width	NEWP#	OLDNEWP#	Thick-Width	NEWP#	OLDNEWP#	Thick-Width
		BLANK			BLANK			BLANK
L0-001	B1	1-1/8" x 5-1/4"	L0-021	B21	15/16" x 4-1/8"	L0-041		15/16" x 3-5/8"
L0-002	B2	15/16" x 5"	L0-022	B22	7/8" x 3-1/2"	L0-042		15/16" x 3-1/4"
L0-003	B3	15/16" x 4-1/4"	L0-023	B23	15/16" x 3-1/2"	L0-043		15/16" x 3-1/4"
L0-004	B4	15/16" x 4-7/16"	L0-024	B24	15/16" x 4-1/16"	L0-044		15/16" x 3-1/2"
L0-005	B5	15/16" x 4-1/2"	L0-025	B25	15/16" x 4-1/8"			
L0-006	B6	15/16" x 4-1/2"	L0-026	C-1	1-1/2" x 3-1/2"			
L0-007	B7	15/16" x 4-1/4"	L0-027		15/16" x 3-3/4"			
L0-008	B8	15/16" x 5"	L0-028		15/16" x 4-3/8"			
L0-009	B9	15/16" x 4-1/4"	L0-029		15/16" x 4-3/8"			
L0-010	B10	15/16" x 4-1/4"	L0-030		15/16" x 4-1/16"			
L0-011	B11	7/8" x 3-1/8"	L0-031		1-1/8" x 5-1/16"			
L0-012	B12	15/16" x 4-1/4"	L0-032		15/16" x 4-11/16"			
L0-013	B13	15/16" x 4"	L0-033		1-3/16" x 4-11/16"			
L0-014	B14	15/16" x 4-1/4"	L0-034		15/16" x 4-3/8"			
L0-015	B15	15/16" x 4"	L0-035		1-1/16" x 4-1/8"			
L0-016	B16	15/16" x 3-7/8"	L0-036		15/16" x 3-5/8"			
L0-017	B17	13/16" x 4-1/4"	L0-037		15/16" x 4-1/16"			
L0-018	B18	3/4" x 2-7/16"	L0-038		15/16" x 4-1/4"			
L0-019	B19	13/16" x 3"	L0-039		15/16" x 4-7/8"			
L0-020	B20	15/16" x 4-1/4"	L0-040		15/16" x 3-9/16"			

# BellyBandCasings

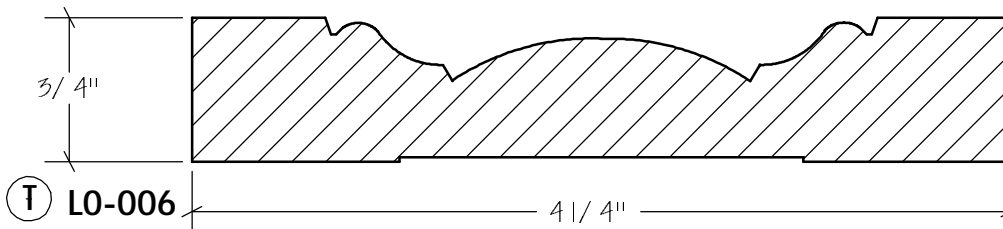
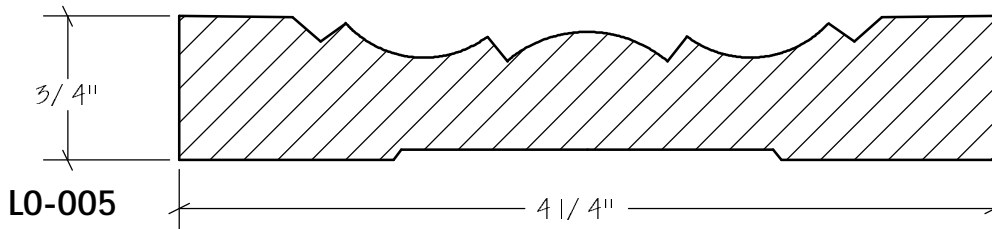
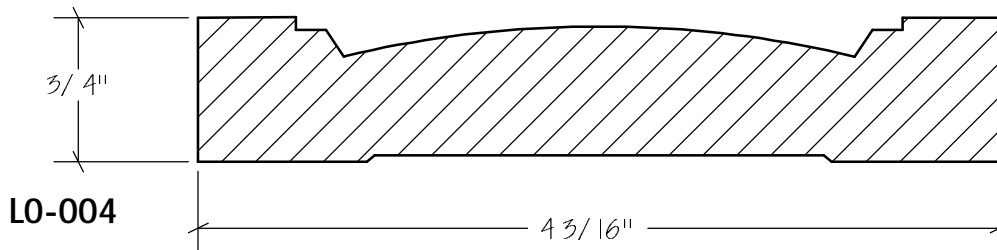
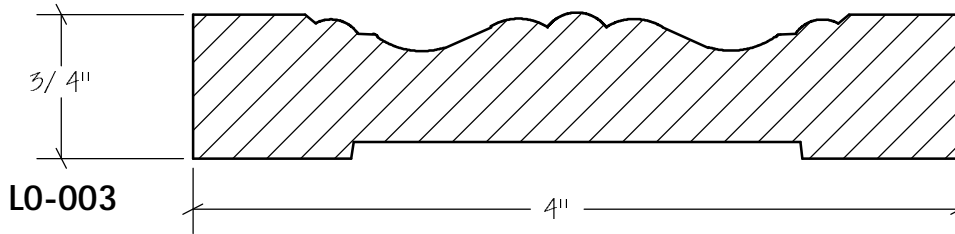
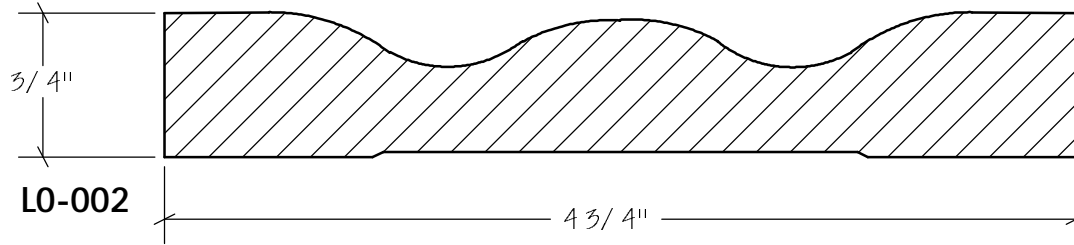
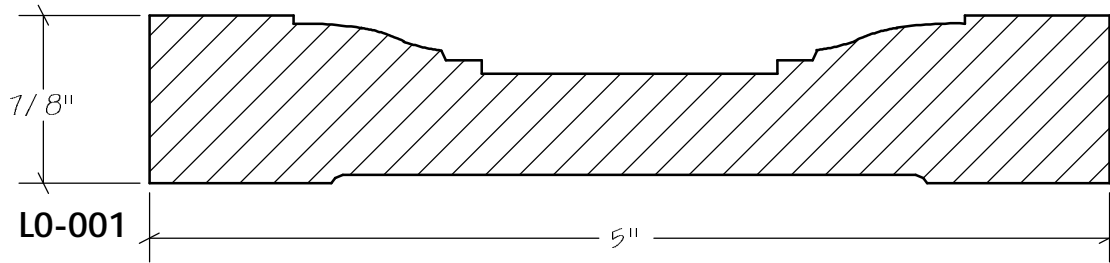

# BellyBandCasings

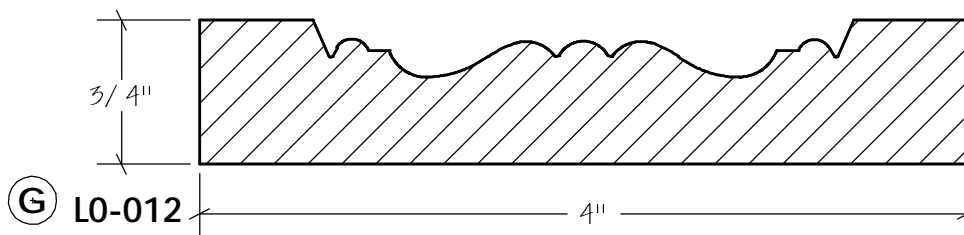
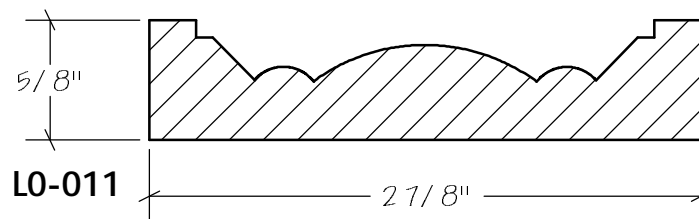
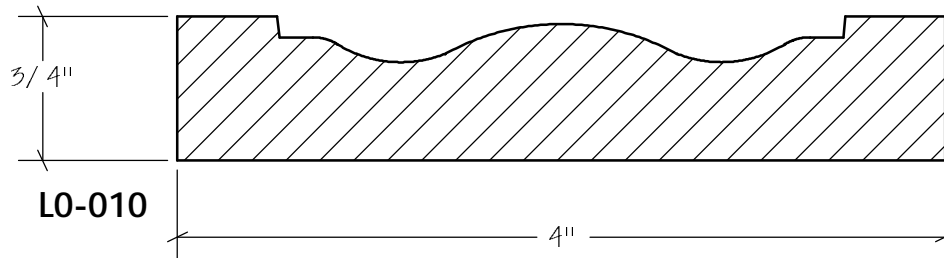
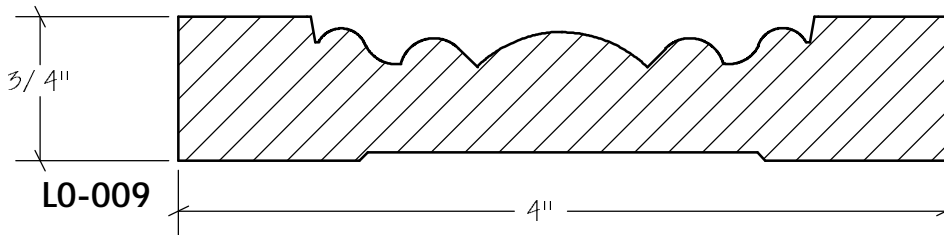
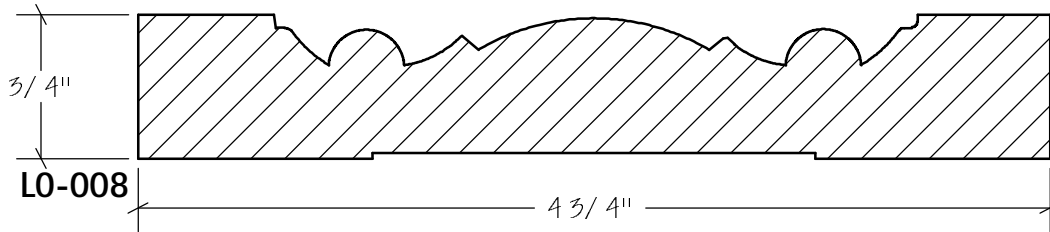
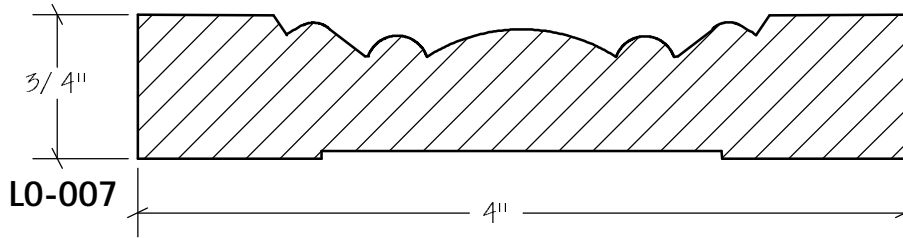

# BellyBandCasings

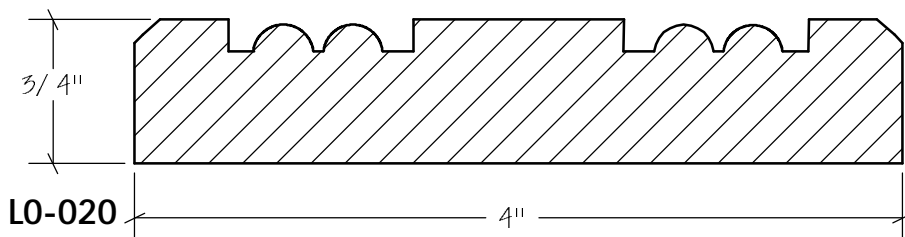
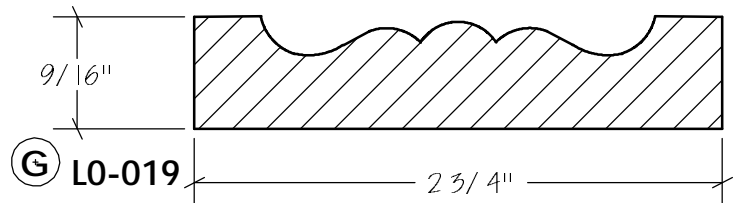
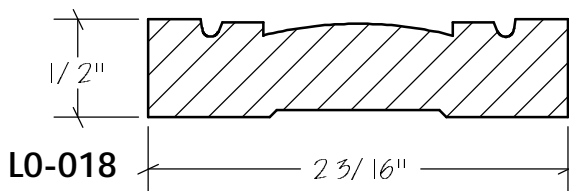
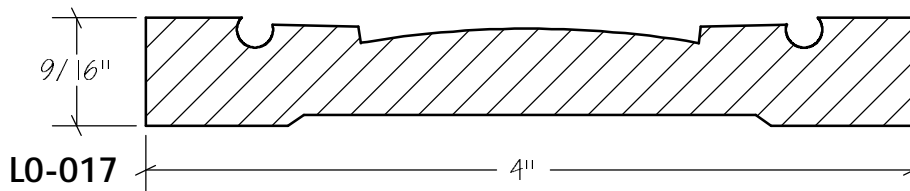
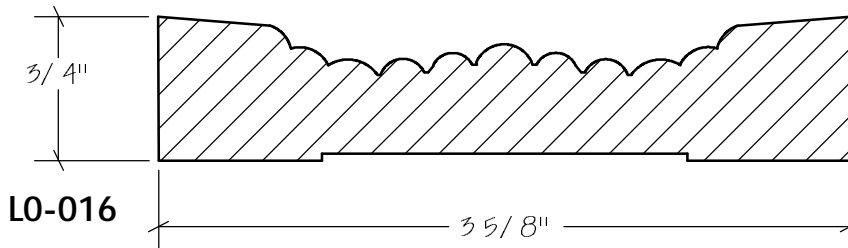
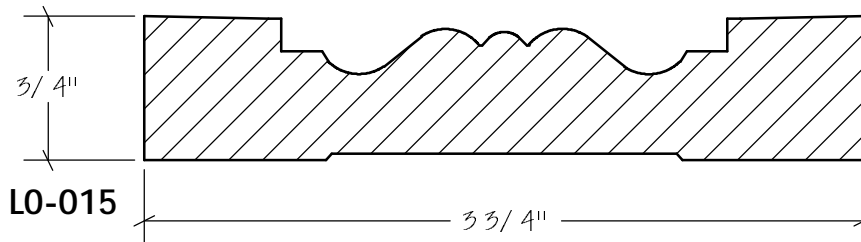
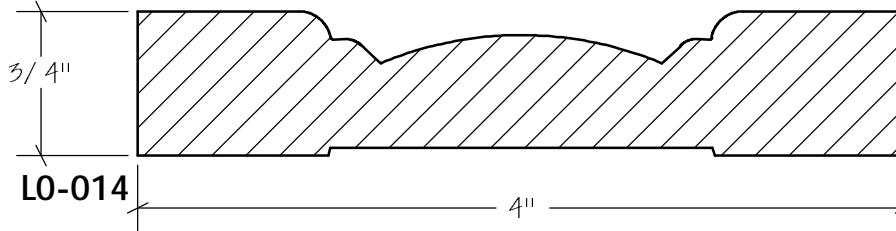
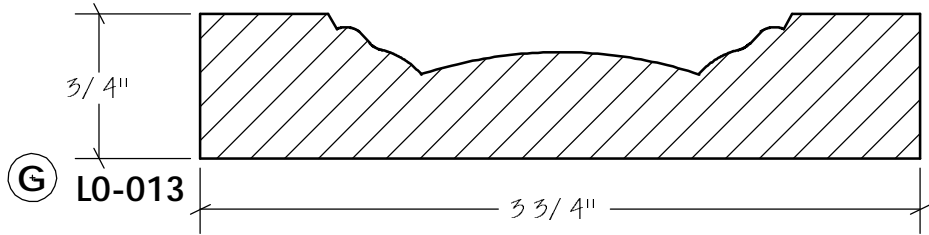

# BellyBandCasings

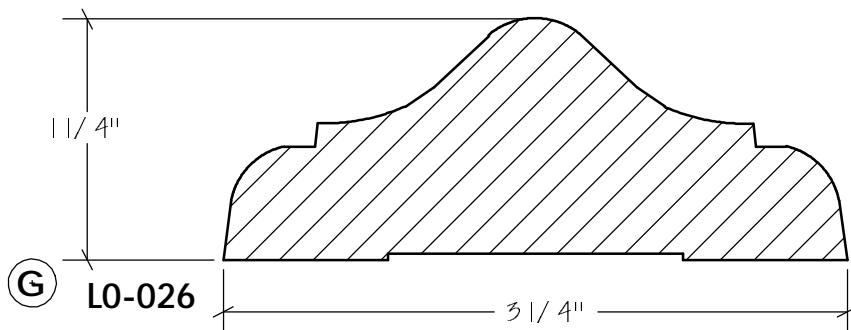
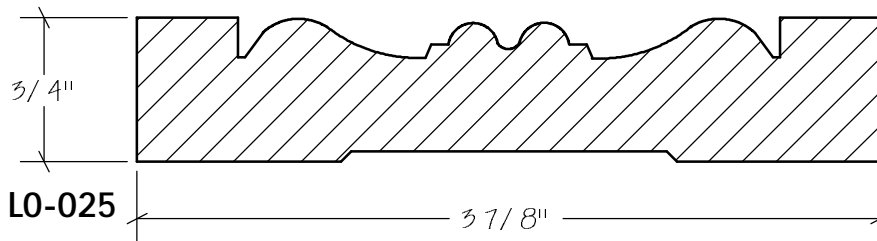
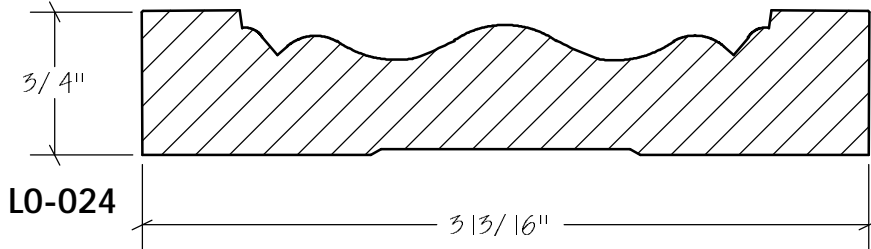
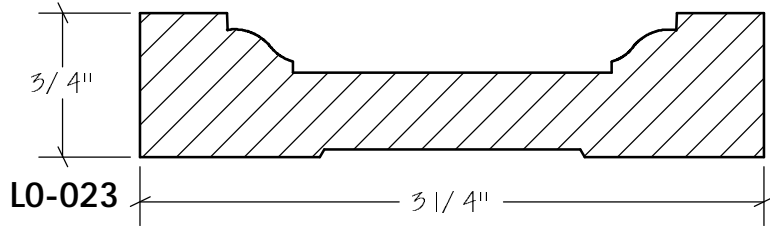
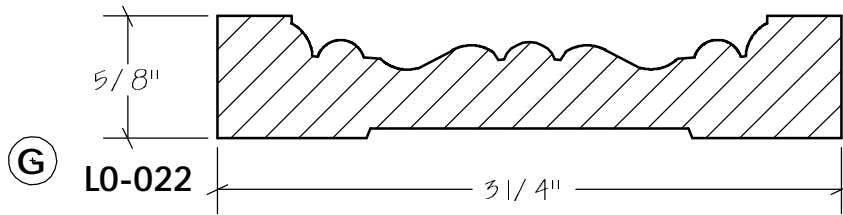
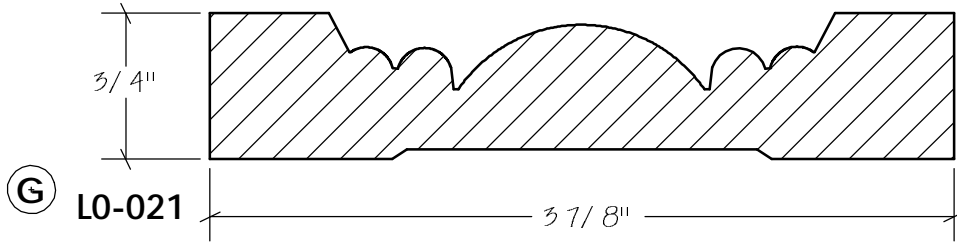

# BellyBandCasings

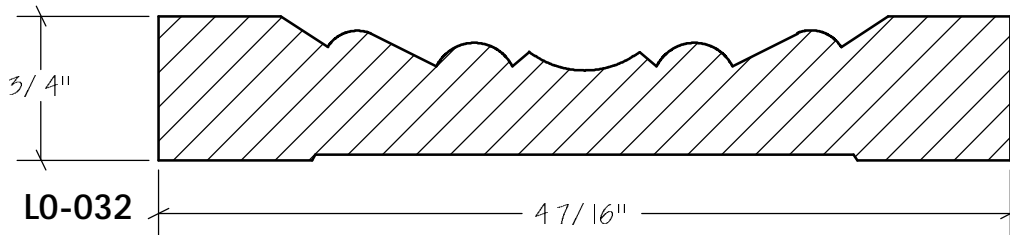
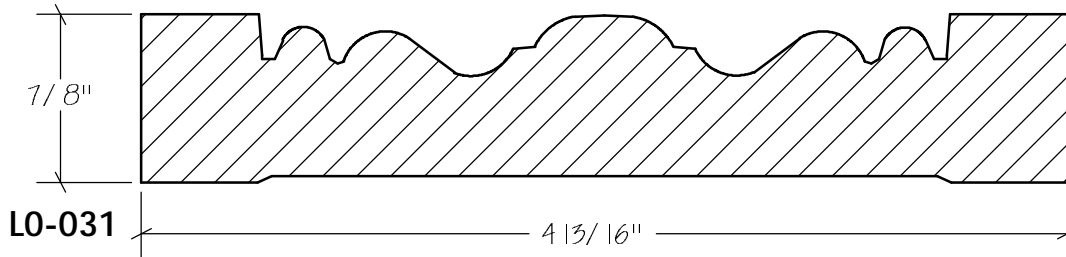
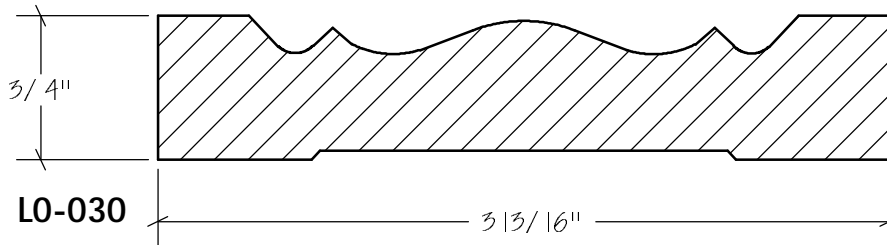
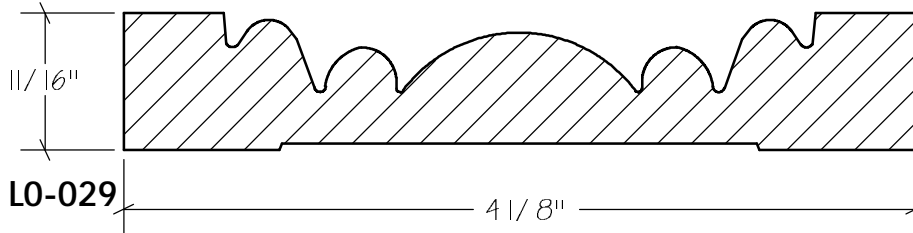
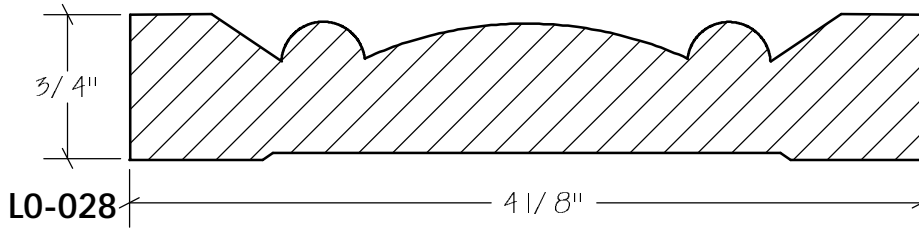
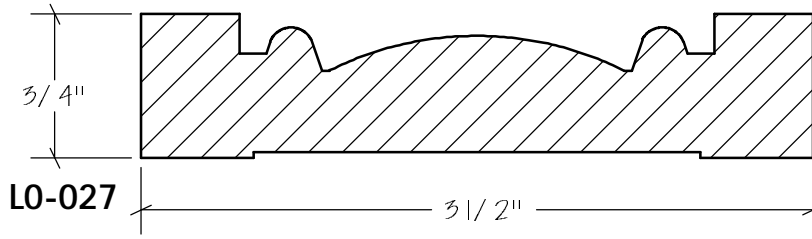

# BellyBandCasings

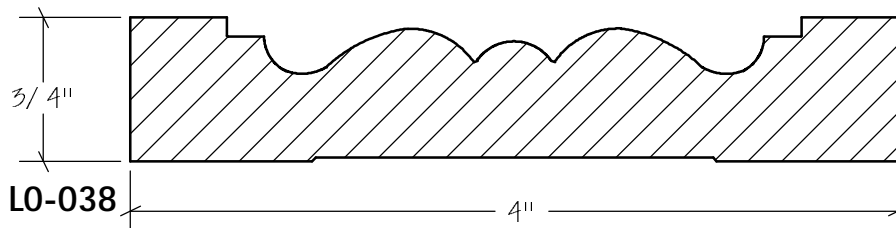
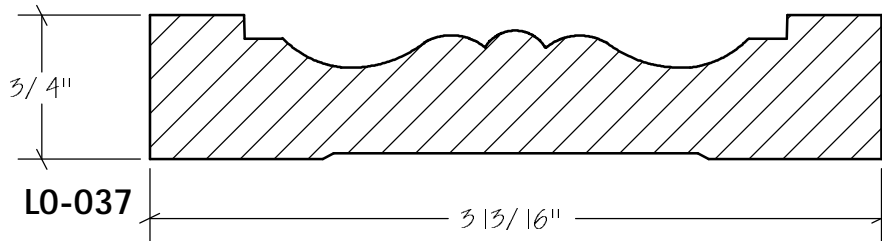
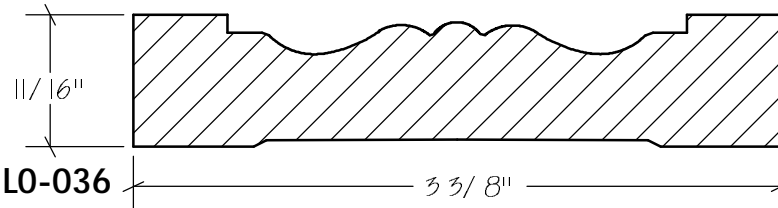
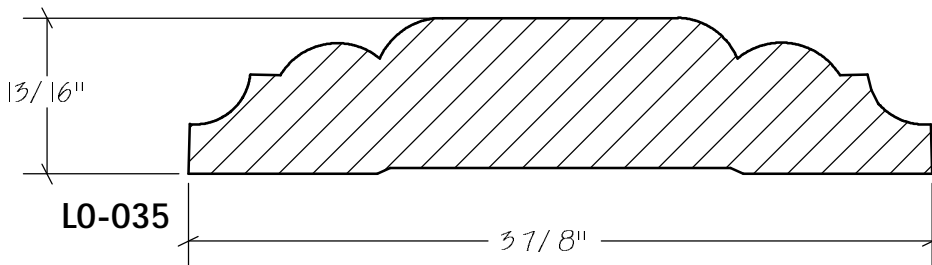
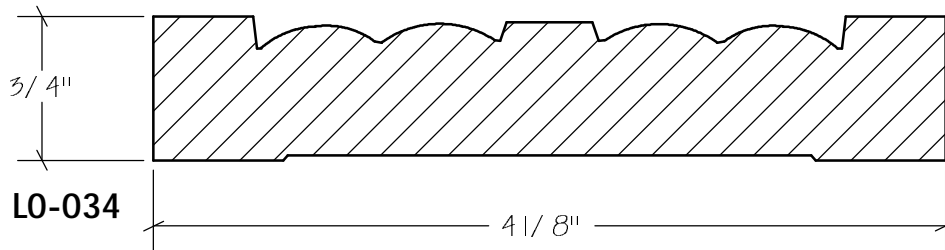
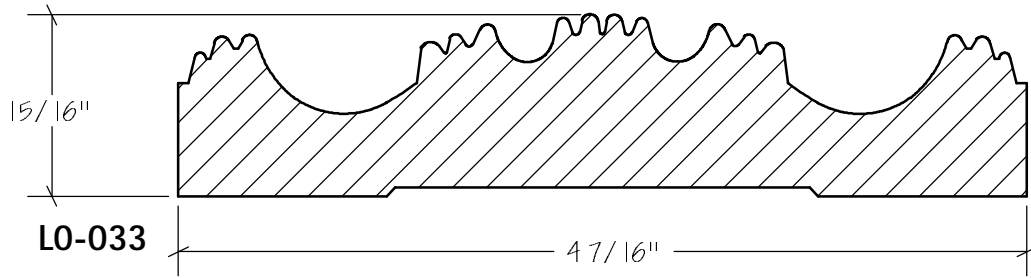

# BellyBandCasings

